

RAY ELECTRIC OUTBOARDS, INC.
OPERATING AND MAINTENANCE INSTRUCTIONS
(Variable Speed Control)

SAFETY PRECAUTIONS

When operating your Ray powered boat observe normal safety precautions applicable to power boating. In particular, do not overload your boat with passengers or cargo. Limit speed, particularly on turns to safe limits. **ALTHOUGH OF MODEST POWER, THESE MOTORS (like other outboards) ARE CAPABLE OF OVERPOWERING WHEN TURNING. BE CAUTIOUS WHEN TURNING OPEN BOATS AND WATCH YOUR FREE BOARD.**

EMERGENCY STOPPING: If normal controls fail to stop motor, pull power plug at motor for emergency stop.

Do not run motor over ½ speed when out of water.

Tie a small float to switch key and always keep a spare key.

ALWAYS REMOVE KEY when storing or docking overnight or longer to assure that key is off and remains off. If key is left on, batteries will be slowly discharged.

WARNING

There is a danger that the Ray outboard may “twist itself off the transom” if not bolted to the transom through the holes in the lower end of each clamp. Because of the large turning radius of the motor enough side thrust and leverage can develop to twist the clamps off the transom. Also rapid powerful reversing, necessary at times may put too much strain on the boat’s transom if the clamps are not bolted. Tiller models are particularly vulnerable to twisting off transom and present a real danger of being lost if operated in deep water without being bolted to the transom.

VENTILATE CHARGER. Failure to adequately ventilate charger voids warranty—see below and see Limited One Year Warranty.

OPERATING

SET LEVER TO RUN. The lever on the front of the outboard must be set to the “R” (Run) position or the unit will pull out of the water when in reverse. (A trip release allows the outboard to kick up to prevent damage when going forward.)

To Tilt Up: Set lever to the “T” (Tilt) position. To lock in the up position pull the small knob “out”. Push small knob “in” to release from locked position.

To Start: Turn key on when speed control lever is in OFF position, then advance speed control **FORWARD** or **REVERSE** to desired speed.

To Stop: Return speed control lever to OFF position.

To Change Directions: Return speed control lever to OFF position, then advance speed control lever in opposite directions – either **FORWARD** or **REVERSE**. Be careful when slowing down not to push the speed control lever so quickly that you go past the OFF position and inadvertently change directions.

To Charge Batteries: Key should be off. Automatic charger: plug in AC plug—charger will start and automatically stop when batteries are fully charged. To activate charger again requires unplugging and plugging in again—charger does not automatically recharge. Manual charger: Plug in charger AC plug. Set charger timer to desired time to charge. **DO NOT CHARGE BATTERIES WITH KEY ON. BE SURE CHARGER HAS ADEQUATE VENTILATION** when charging, particularly in hot weather. Inadequate ventilation will cause diodes to overheat and fail (indicated by a blown charger fuse). Do not leave charger in a fully enclosed boat seat when charging. Remove top of seat or remove charger from seat.

Shear Pin Replacement: If your motor is not protected with a slip clutch (or if for any reason clutch does not function properly), the drive mechanism is protected by the propeller shear pin when the propeller strikes an obstruction.

DO NOT ATTEMPT TO REMOVE THE PROPELLER OVER THE BROKEN SHEAR PIN – follow these instructions. Carry the following equipment for shear pin replacement:

1. Shear Pin (includes 2 small cotter pins)
2. Cotter Pin
3. Pliers
4. Spike nail or 3/16” punch

Remove both ends of the broken shear pin from the prop by pulling outward. It is not necessary to remove the shaft cotter pin and washer.

DO NOT ATTEMPT TO REMOVE THE PROPELLER OVER THE BROKEN PIN. Note that there are two holes in the prop hub. The larger one is for shear pin removal only. Align the larger hole with the shaft hole with the broken pin in it and drive the center piece of pin out with a punch or spike nail.

Install a new shear pin in the proper (smaller) hole and secure with small cotter pins.

WARNING

DO NOT USE STEEL SHEAR PINS AS A REPLACEMENT FOR THE BRASS SHEAR PIN. Gears will be ruined and will not be covered under warranty.

Outboards Equipped with Optional Slip Clutch: The purpose of the clutch is to prevent shearing pin if the propeller strikes an obstruction. The clutch is not designed for continuous slippage. If slipped for more than a short period of time, excessive heat will be generated and the clutch may be damaged. If the propeller becomes continuously obstructed, stop the motor immediately and free propeller. Excessively slipped clutch may be considered abnormal operation under terms of warranty.

Battery Condition Meter:

- The meter indicates true battery condition only in top speed. On lower speeds, the meter reads high. Without the motor running, the meter reading is very high and inaccurate.
- When the needle reaches the edge of the “red” (charge) in top speed it is time to recharge the batteries.

System No.	Rated HP	Volts	Number of Batteries	Total System Weight lbs.	Trolling Speed (Example)			Medium Speed (Example)			Top Speed (Example)			
					HP	Running Time in Hrs.	Amps	HP	Running Time in Hrs.	Amps	HP	Running Time in Hrs.	Amps	Thrust pounds
500	5.0	60	10	765	.4	35	7.0	2.0	5.8	34	5.0	1.8	84	270
300	4.0	48	8	650	.3	38	6.5	1.5	6.0	32	4.0	2.0	80	195
200	2.5	36	6	510	.3	28	8.7	1.0	6.6	29	2.5	2.7	65	135

*Total System Weight (TSW). TSW does not include charger, which weighs 32 pounds.
Note: Running time (RT) based on 135 minute rated golf cart batteries.

Electrical Accessory Connection and Operation – See INSTALLATION INSTRUCTIONS.

MAINTENANCE

Gear Case: The gear case is filled with 10W-40 multiweight oil. Check the oil level at the beginning of the boating season. Remove plug with screwdriver. Proper level is indicated when the oil is level with the bottom of the plug hole, or slightly above, with motor vertical. To add oil use a small hand pump oiler available at hardware stores.

Pivot Bearings: The pivot bearings (steering) should be greased once a year with a grease gun with only about two pumps.

Apply a few drops of oil between clamps and pivot bracket (tilt bearings) once a year. (Not necessary during first year.)

On boats constantly in water TILT OUTBOARD UP WHEN NOT IN USE to keep clean.

The electric motor normally operates for years without attention. Bearings are prelubricated.

Care of Finish: Clean with an automotive cleaner/wax once a year. This care will greatly retard inevitable weathering and dulling of the enamel finish.

Batteries: Keep batteries up to full charge at all times. Charge immediately after use. When not in use, charge once a month. Charge for only 6 hours with manual charger. Check and add water as often as necessary to assure that fluid never goes below the plates. Key should be off when batteries are charged. Keep terminals greased to prevent corrosion.

Winter Care: If your boat is left in the water during the winter it is not necessary to remove the batteries from the boat in most climates. It IS necessary that the batteries be kept fully charged to prevent freezing. During winter (temperatures below 60 degrees F) batteries self discharge less. Charging once every two months for four hours should keep them fully charged, or turn on your automatic charger. When temperature is above 60 degrees charge once every month for four hours, or turn on your automatic charger. Removing the motor and storing it indoors is advised if near salt air or if weather conditions are severe, but in most locations removal is not necessary. Be sure to tilt the motor up out of the water. Covering with canvas or plastic is not usually necessary. The control console, however, should be covered to keep out rain or snow.

SYSTEM 500, 60 VOLTS
6-VOLT BATTERIES

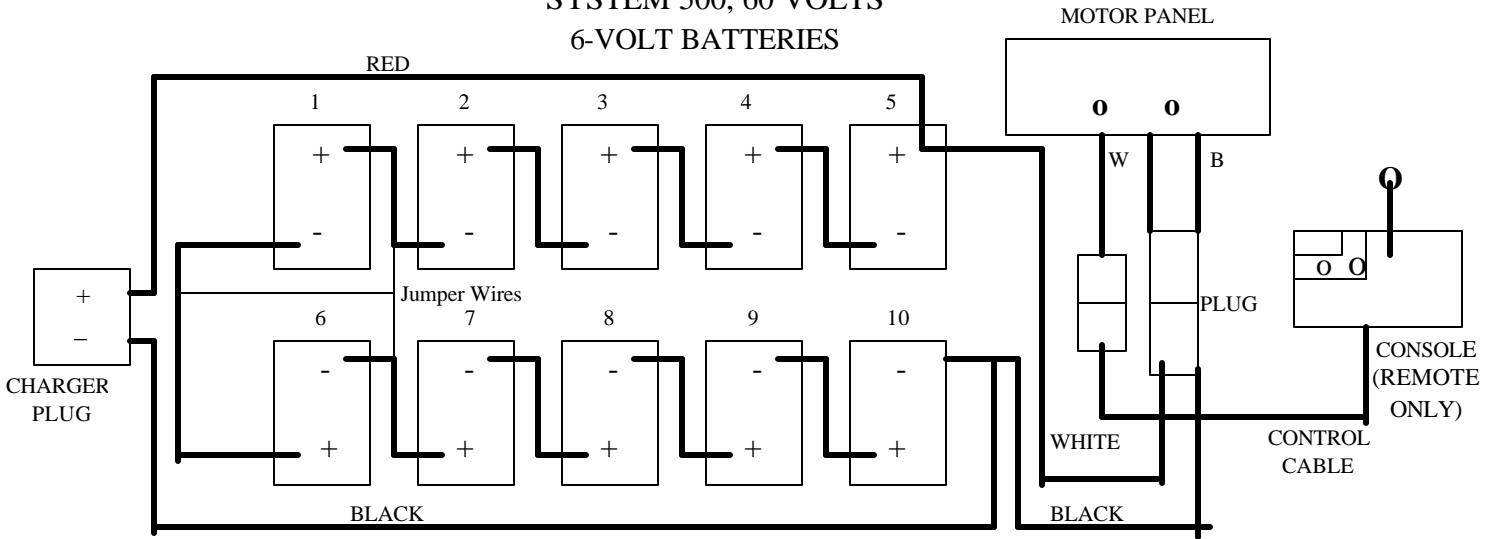

SYSTEM 300, 48 VOLTS
6-VOLT BATTERIES

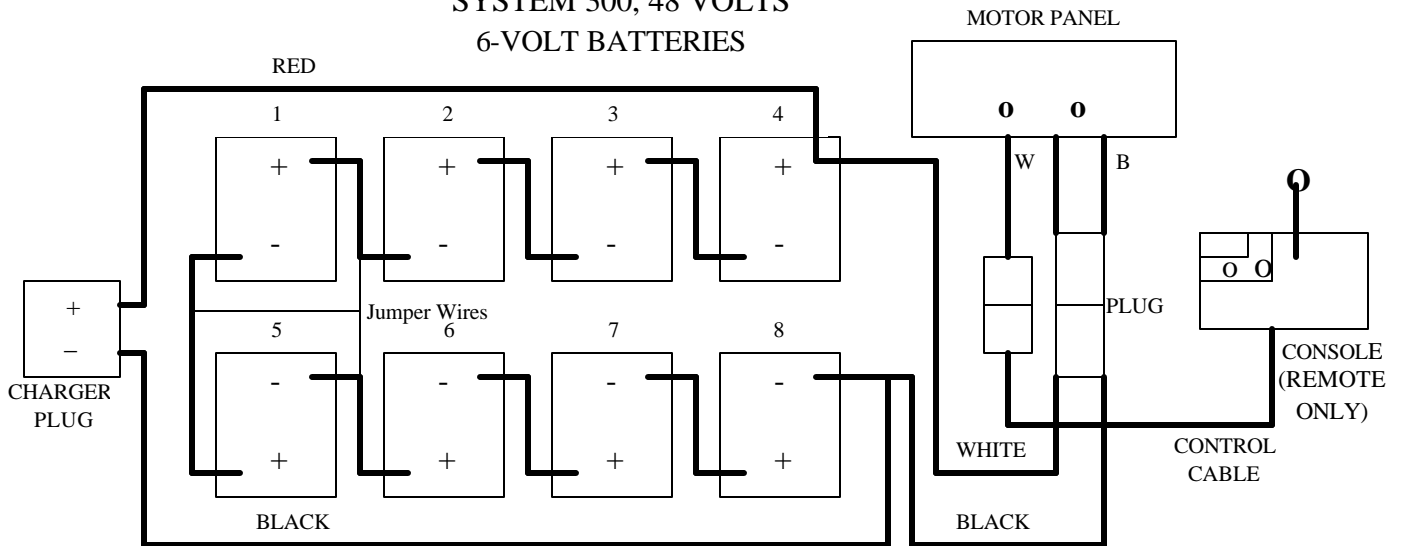

SYSTEM 200, 36 VOLTS
6-VOLT BATTERIES

